

# MONTAGEANLEITUNG

## EINZELGARAGE



GRUPPE

QUALITÄT FÜR HÖCHSTE ANSPRÜCHE



DEUTSCHER  
QUALITÄTSSTANDARD



KOSTENLOSE LIEFERUNG  
DEUTSCHLANDWEIT!

\*AUSGENOMMEN INSELN



BAUDISCOUNT  
ZERTIFIZIERTES  
ONLINEPORTAL

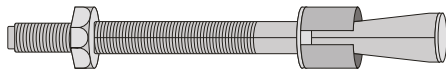
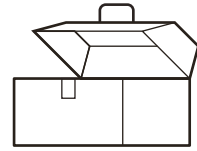
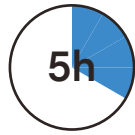
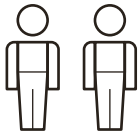
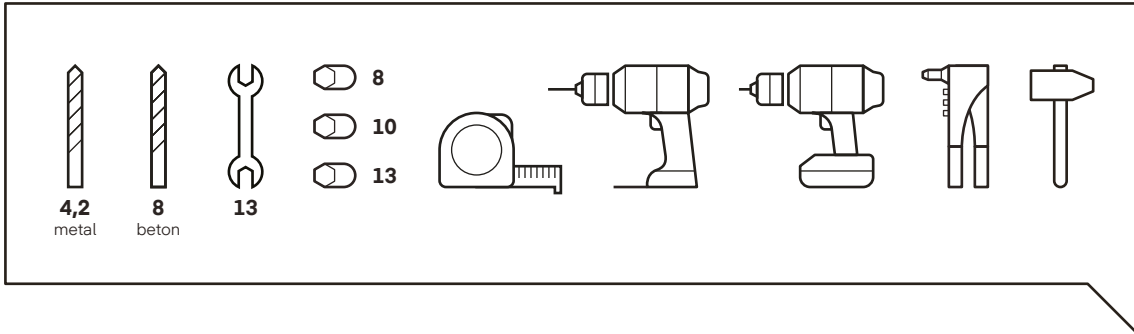

D8\*75

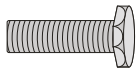

M8\*16

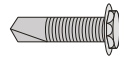

4,8\*19

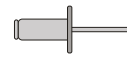

4\*8

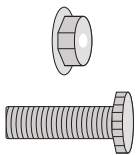

M8\*15,5



UPDM 14

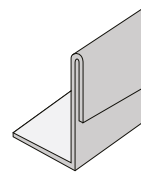
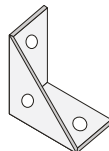
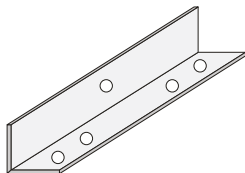

**T18** Dachblech

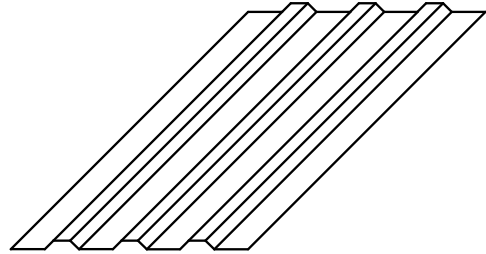

**BM** Zierblende



**BDL** **BDF** **BDP** Dachblende



**KDT** **KDL** **KDF** Dachwinkel

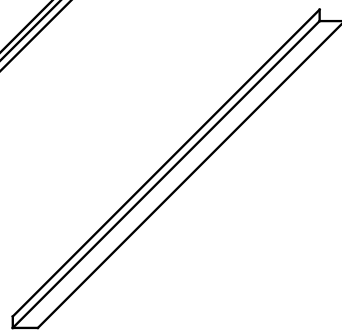

**BN** Eckblende



**Z** Dachbalken (C-Träger)

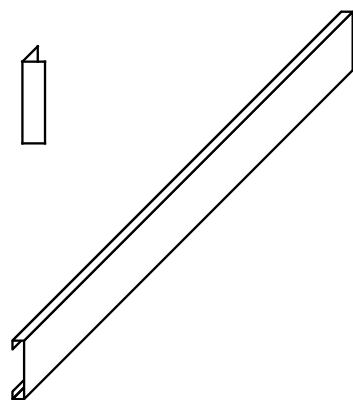

Die Fachgerechte Montage sollte durch einen Zertifizierten Montagebetrieb erfolgen.

Sollten Sie die Montage in Eigenverantwortung durchführen, halten Sie sich an die in der Anleitung und in dem Montage Video beschriebenen und gezeigten Arbeitsschritte.

Voraussetzung für die fachgerechte Montage ist ein nach DIN erstelltes frostsicheres Fundament.

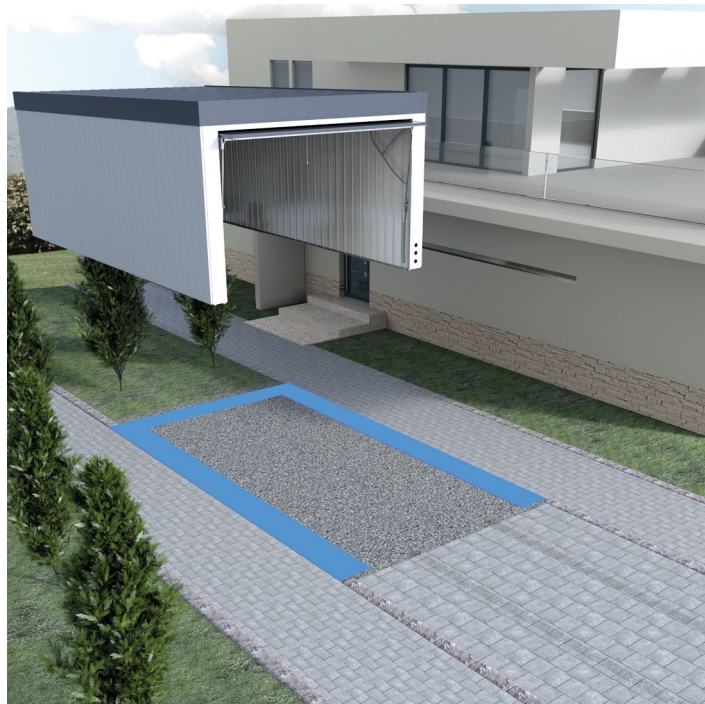
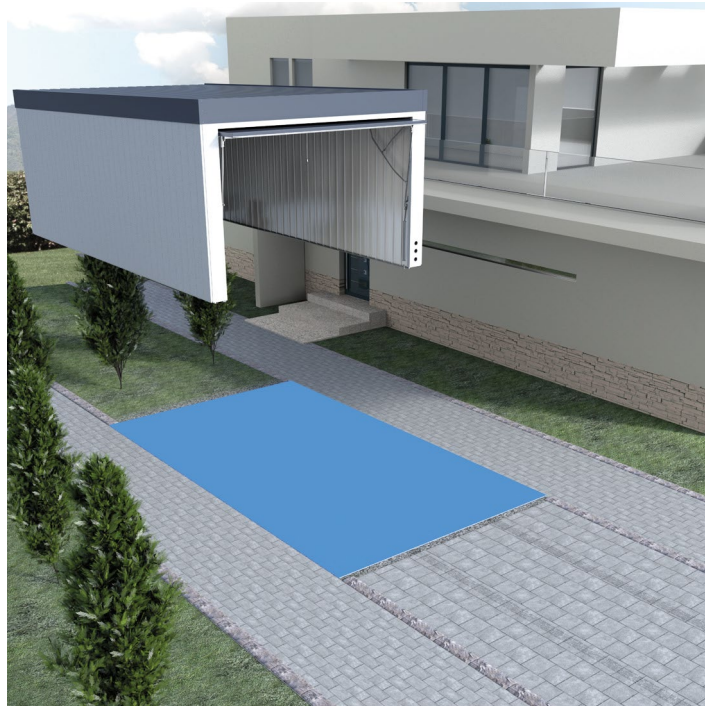

Die Montage der einzelnen Wandelemente muss nach Herstellervorgabe erfolgen.

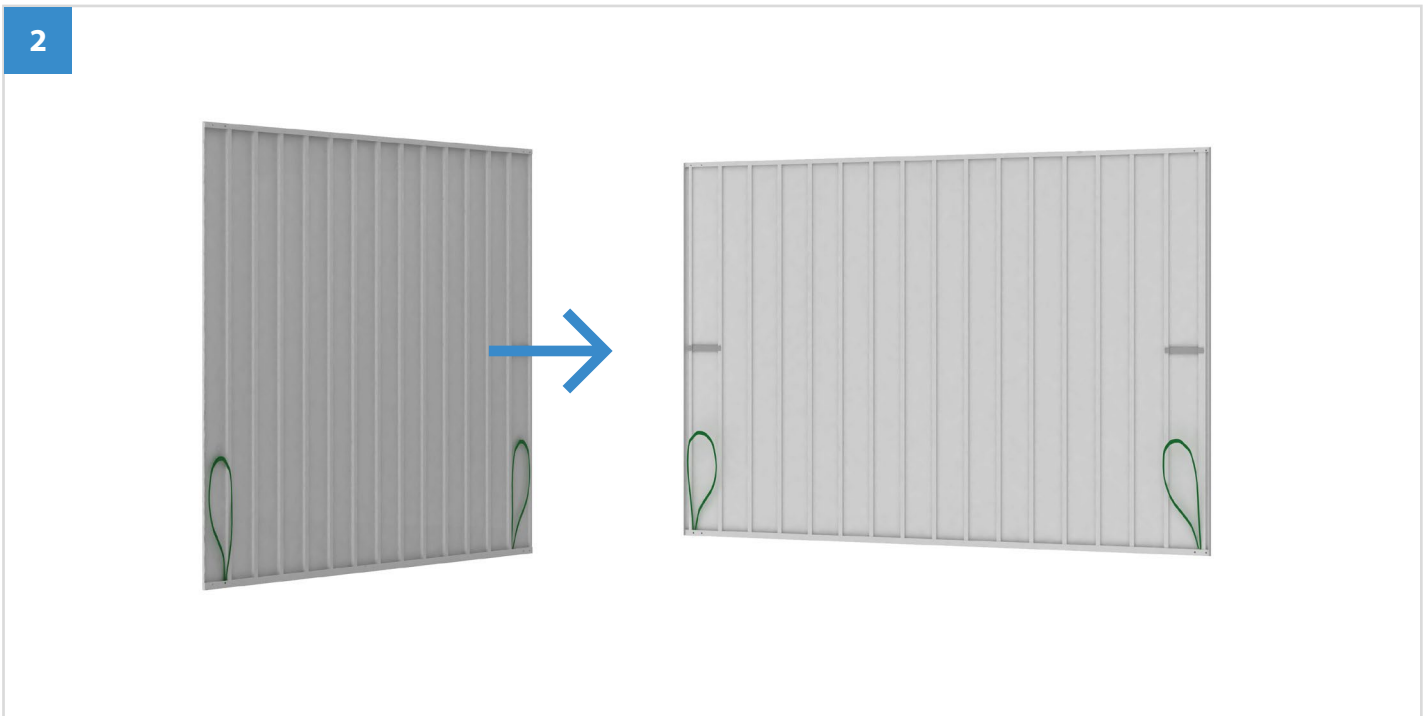



3

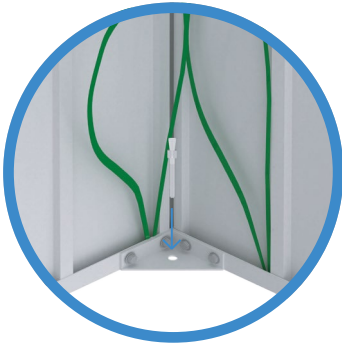
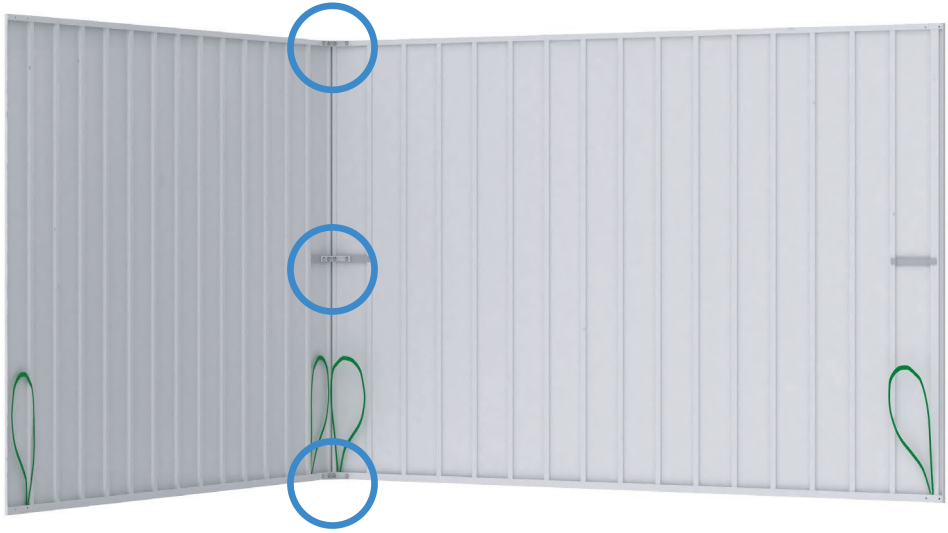

M8\*16 + Schraubenmutter

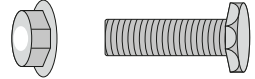

D8\*75

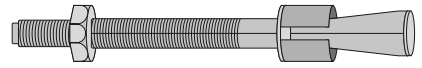

4

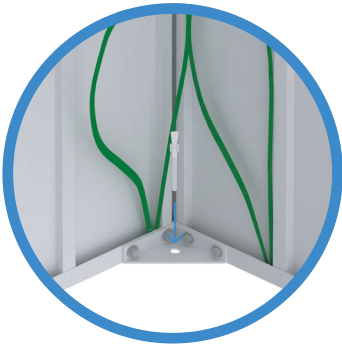
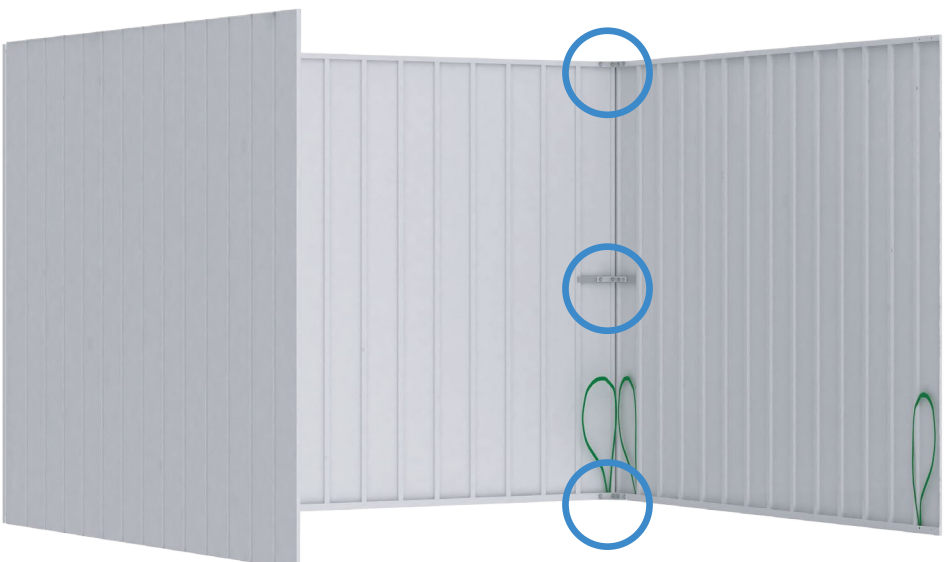

M8\*16 + Schraubenmutter

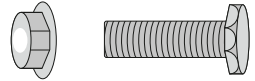

D8\*75

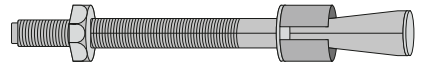

5

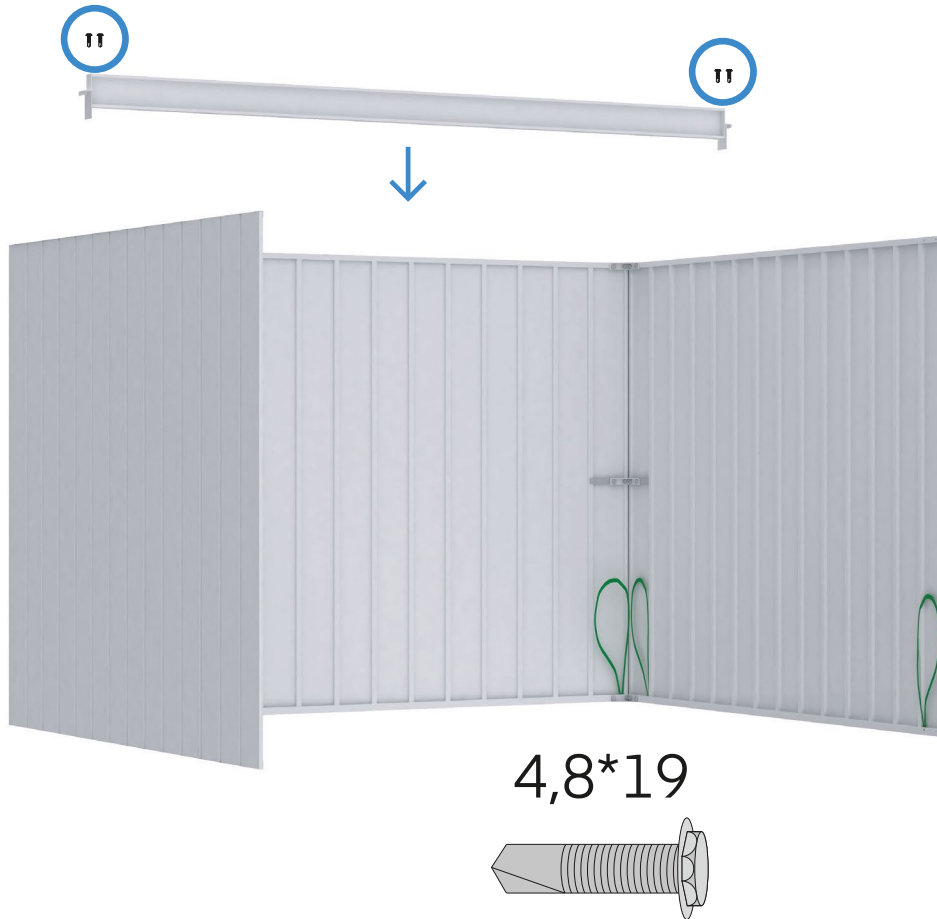

6

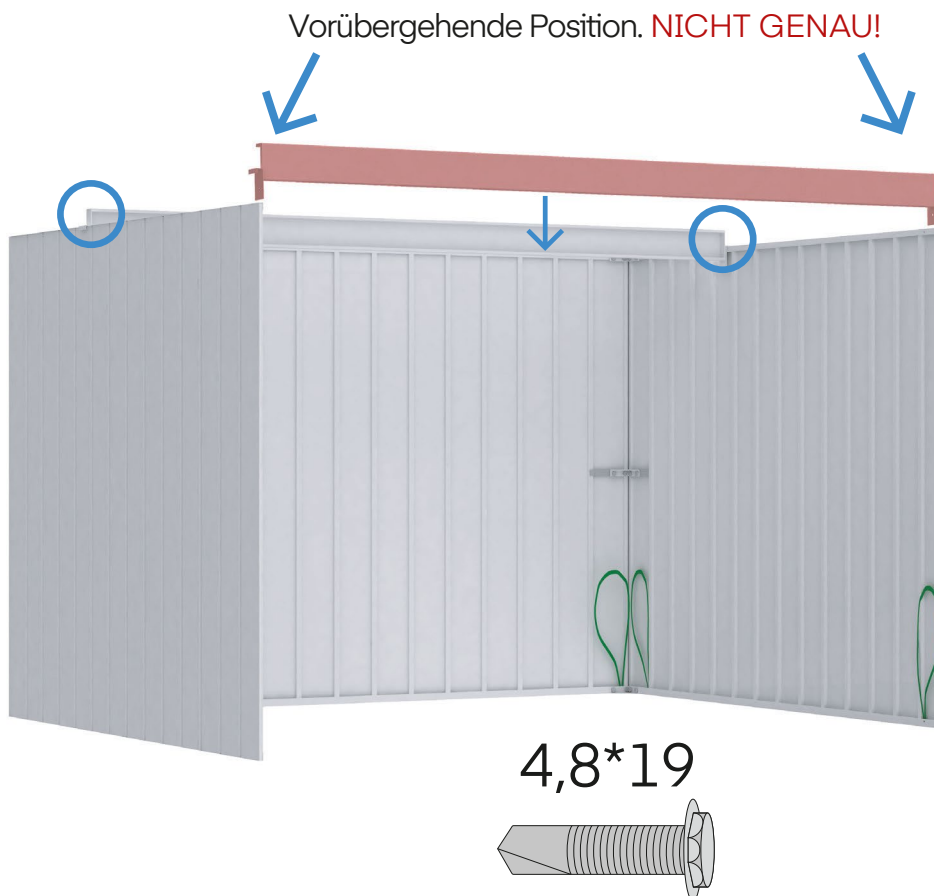

7

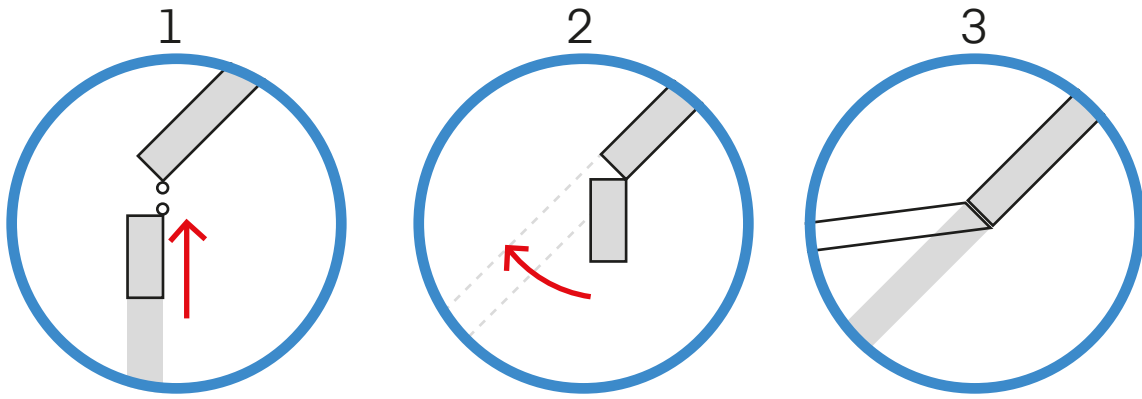

8

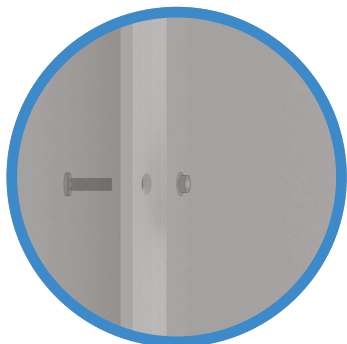
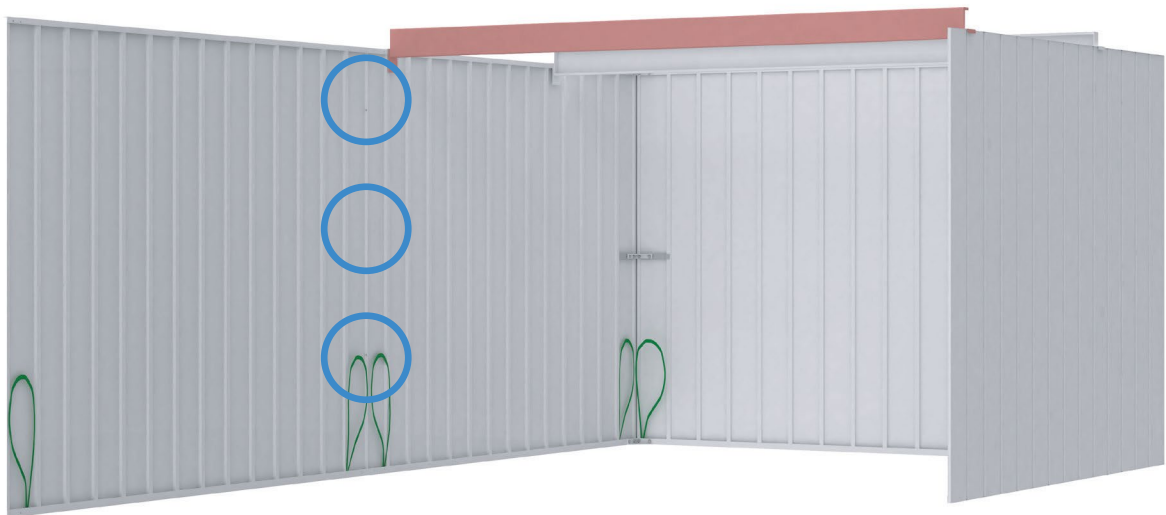

M8\*15,5 + Schraubenmutter

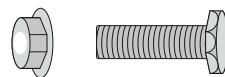



9

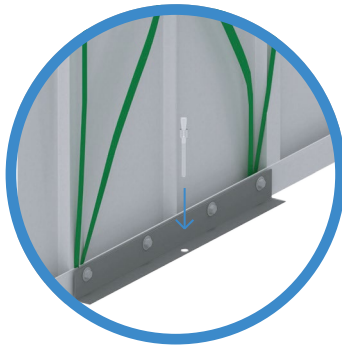
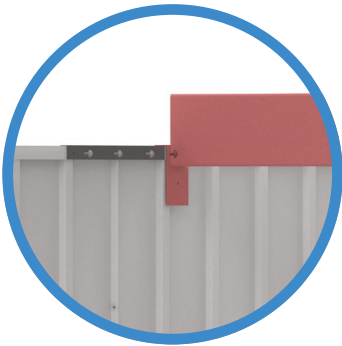
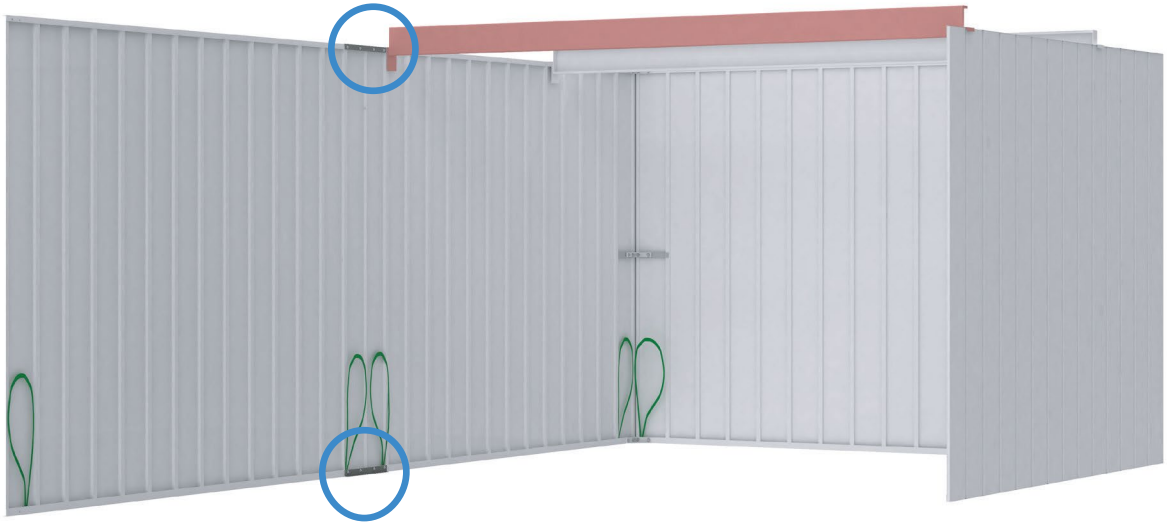

M8\*15,5

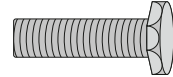

D8\*75

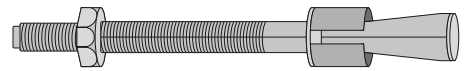

10

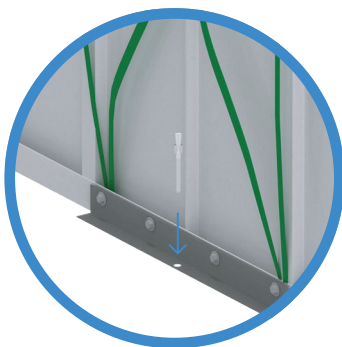
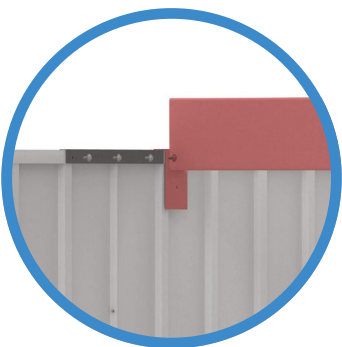
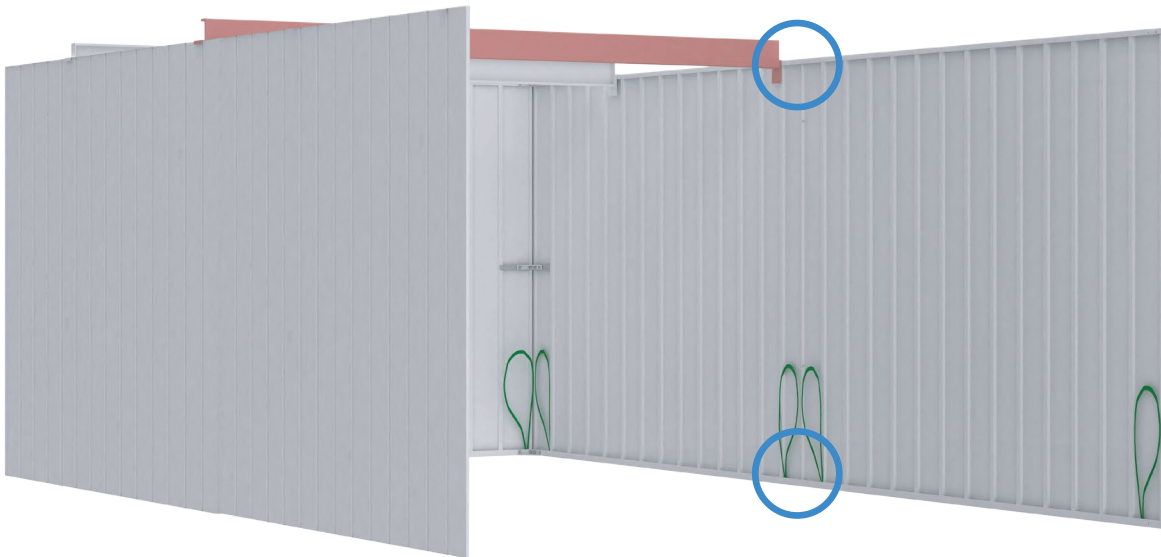

M8\*15,5

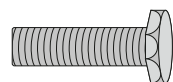

D8\*75

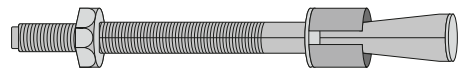

11

Bringen Sie den Dachbalken in die richtige Position.

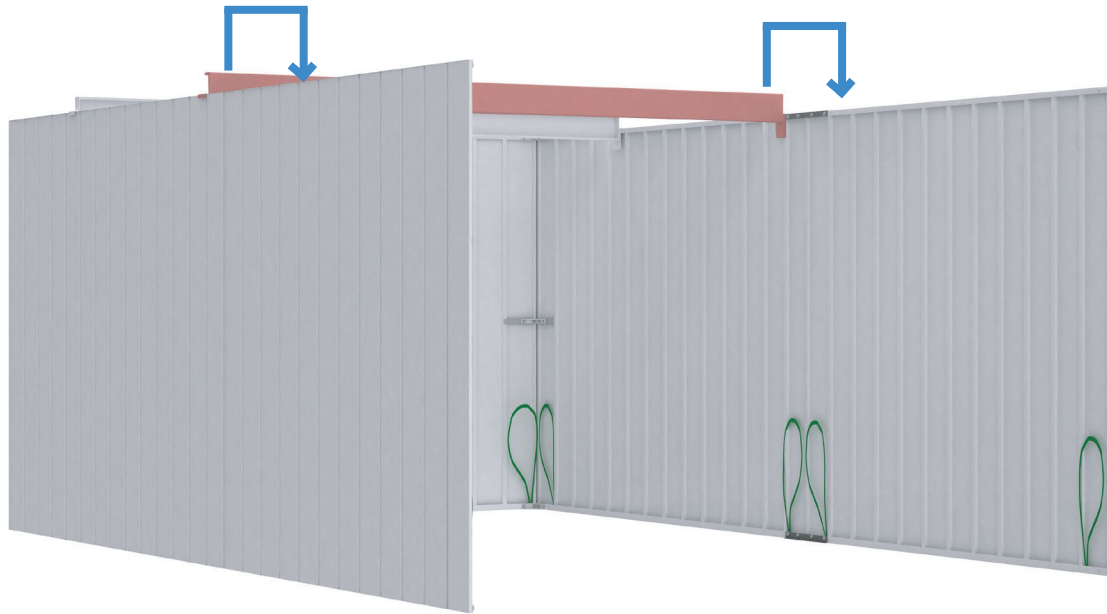

4,8\*19

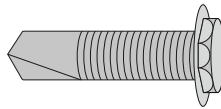

12

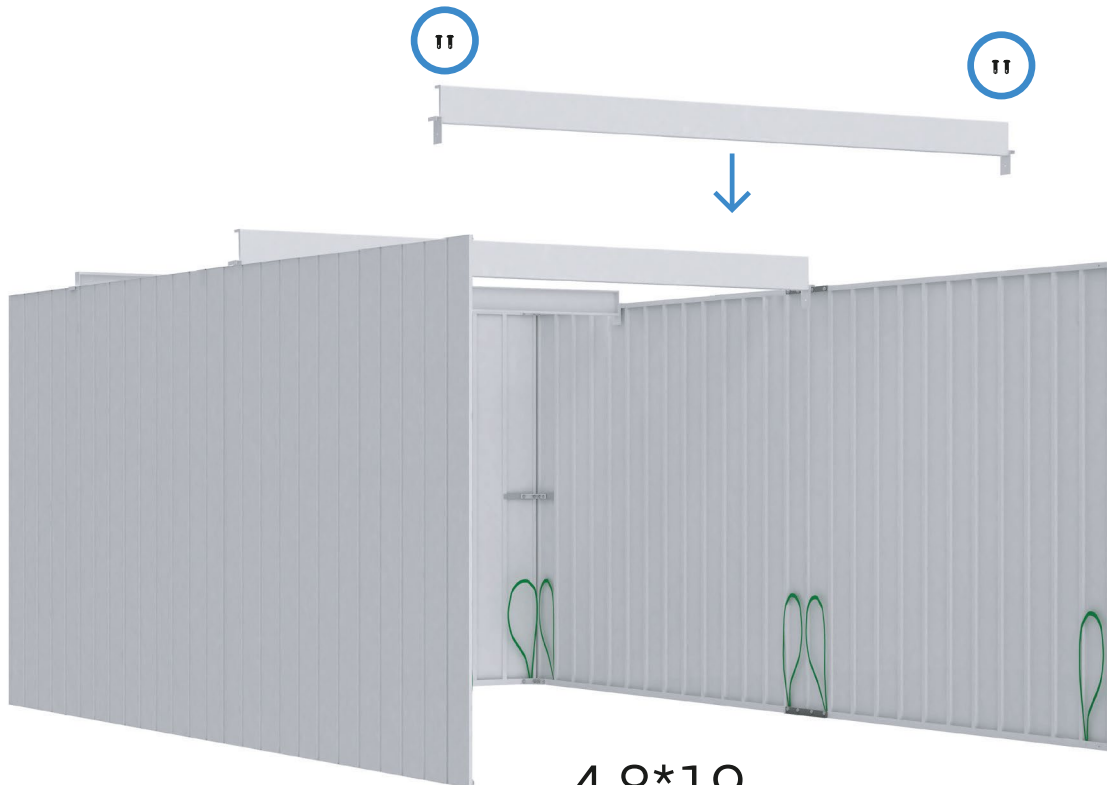

4,8\*19

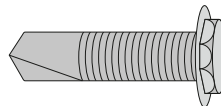

13

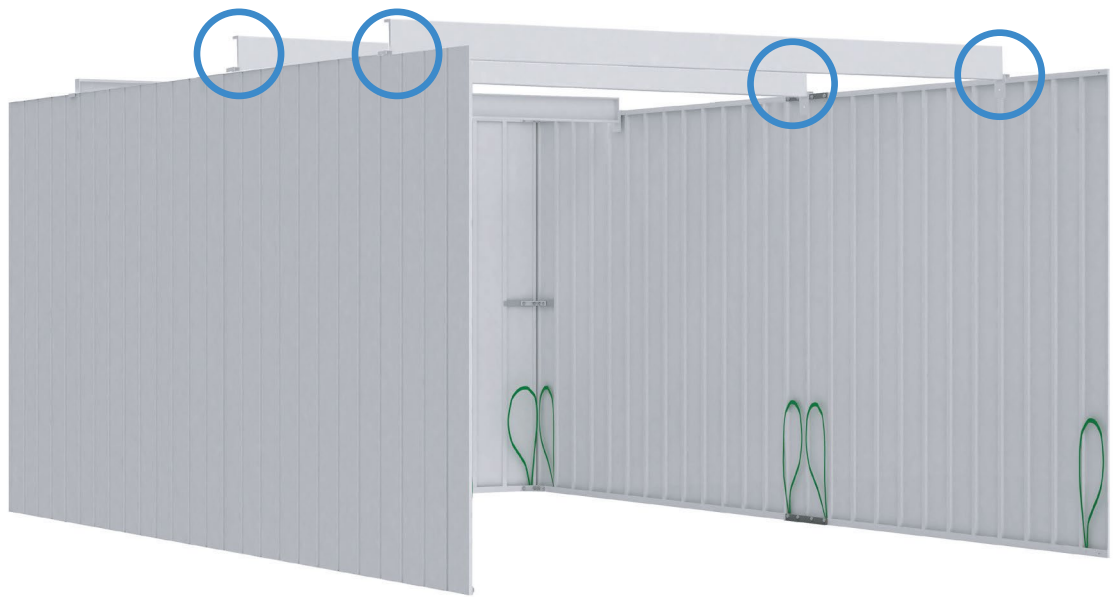

4,8\*19

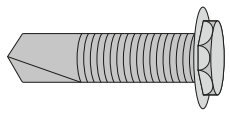

14



15

Zuerst die Diagonalen ohne Tor überprüfen.

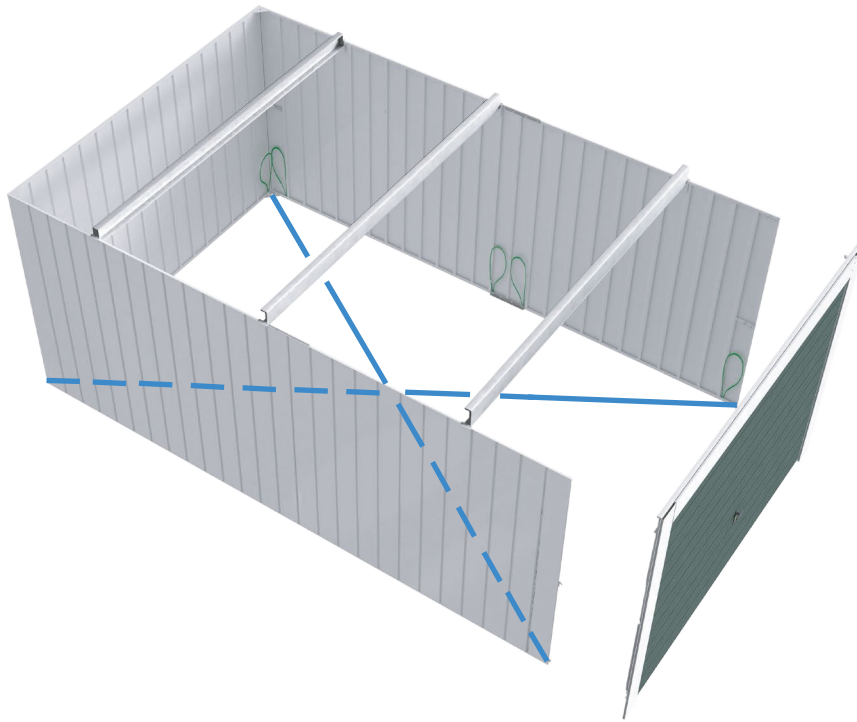

16

Im nachhinein die Diagonalen mit Tor überprüfen.

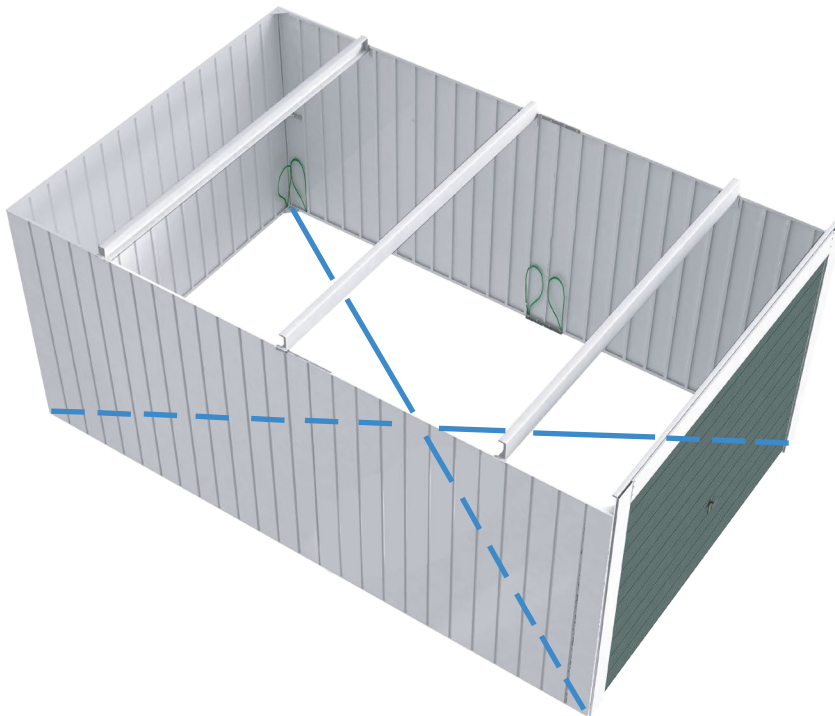

**Achtung wichtig! - bei der Ausführung mit Antikondensvlies.**





17

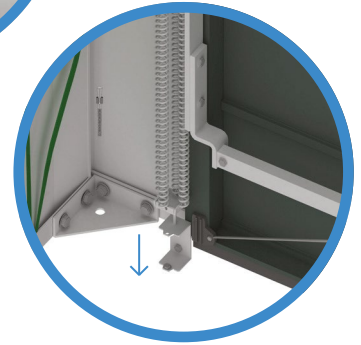
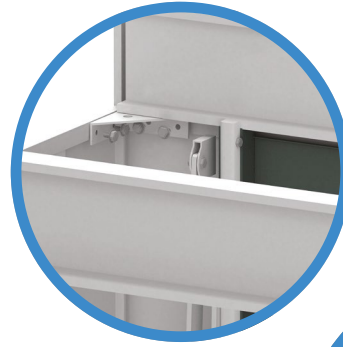
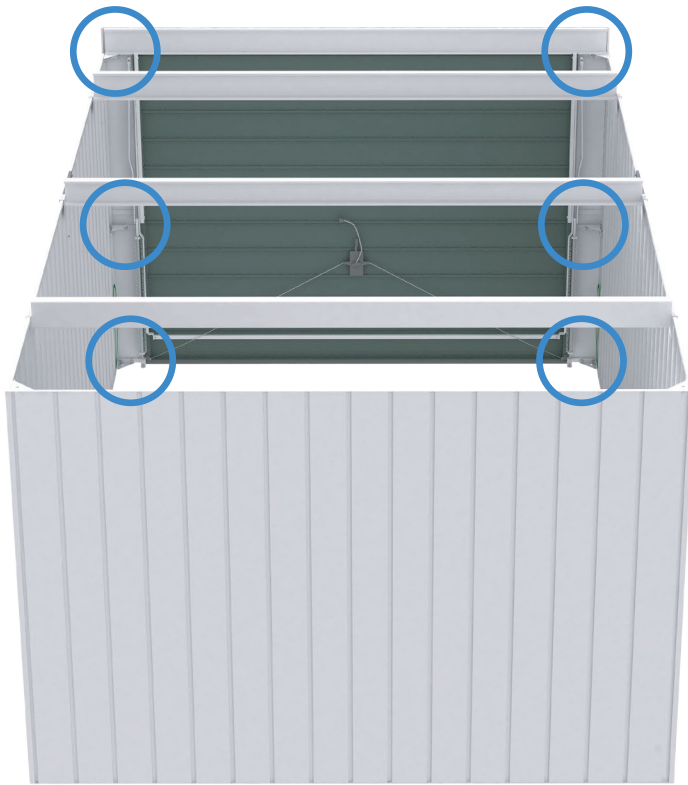

M8\*16

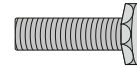

D8\*75

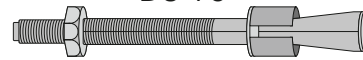

18

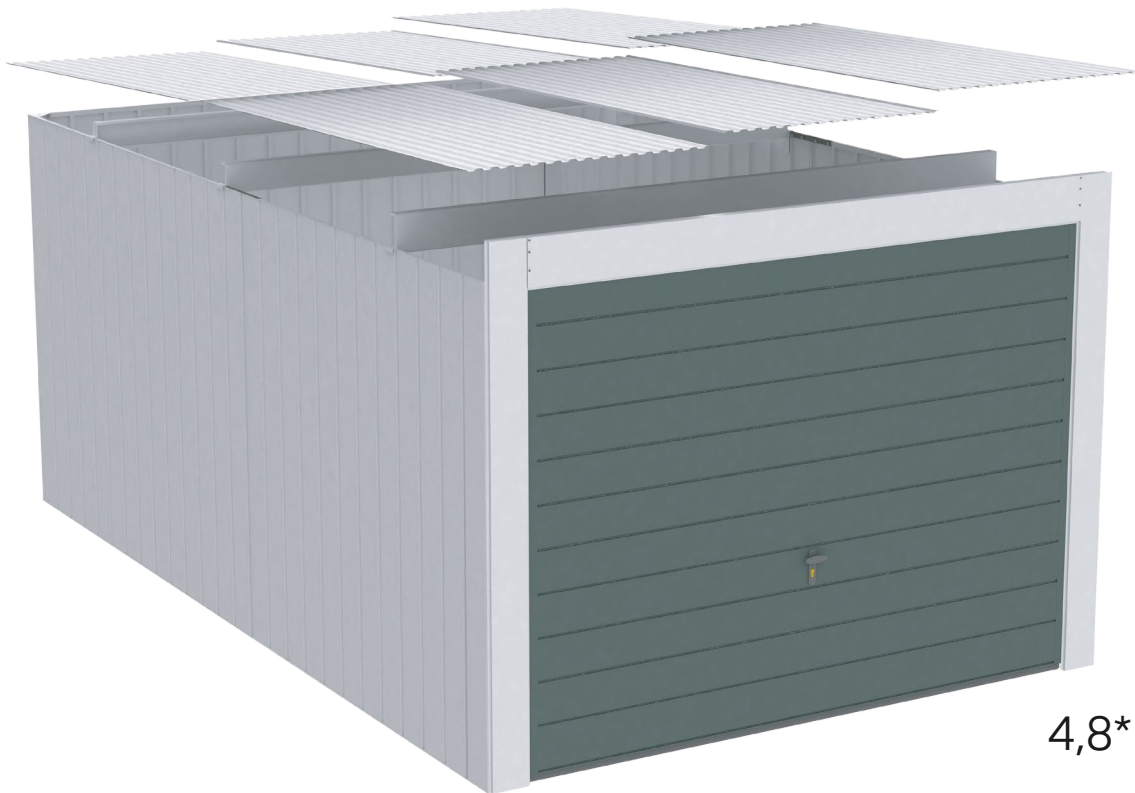

4,8\*19

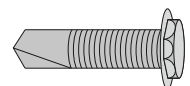



19

Vorläufige Zierblende zur Positionsbestimmung.

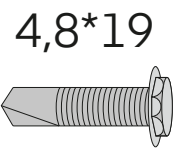
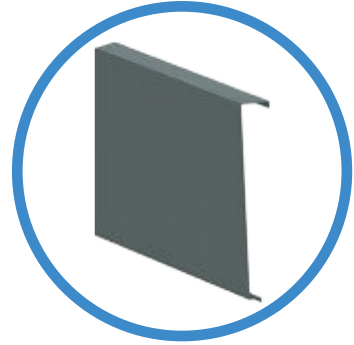
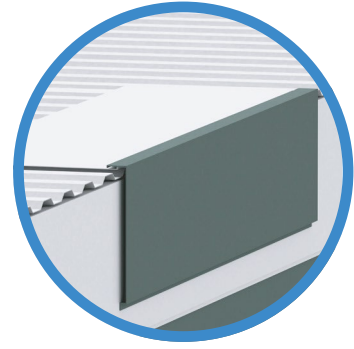
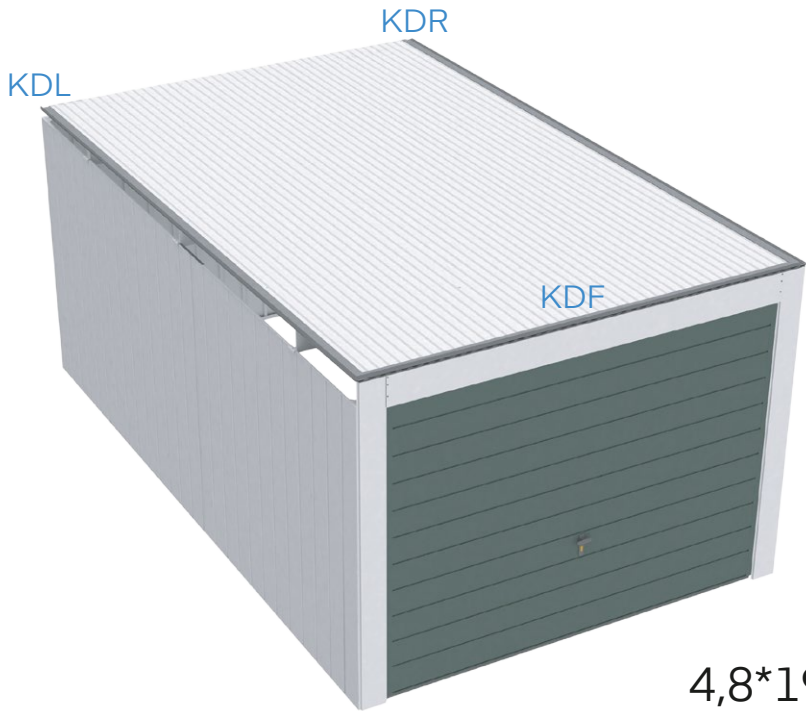

20

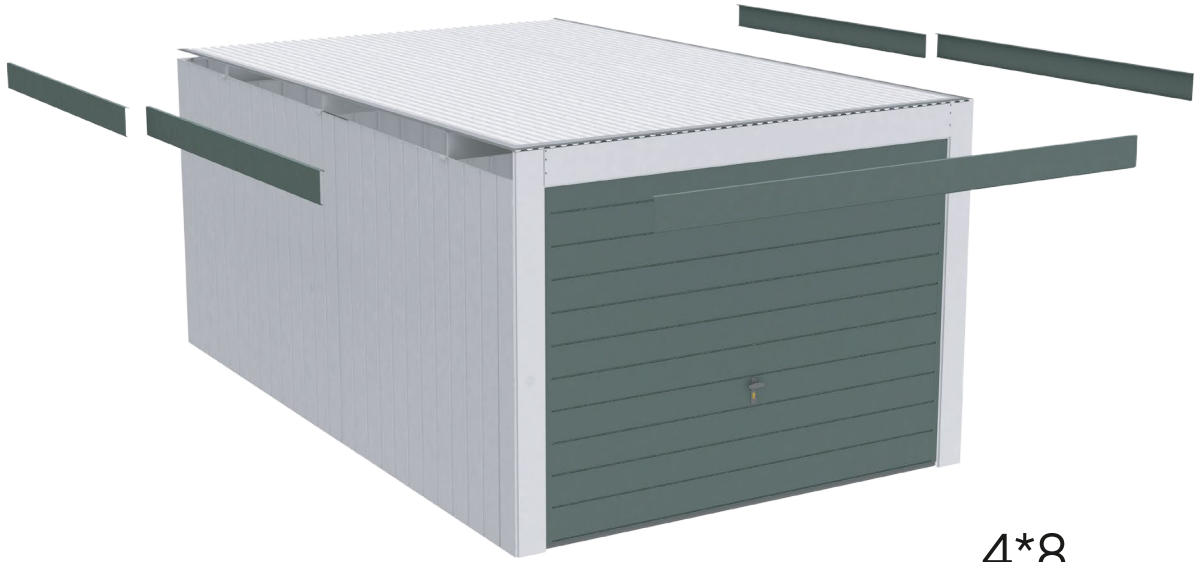

4\*8

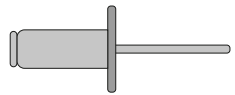

21

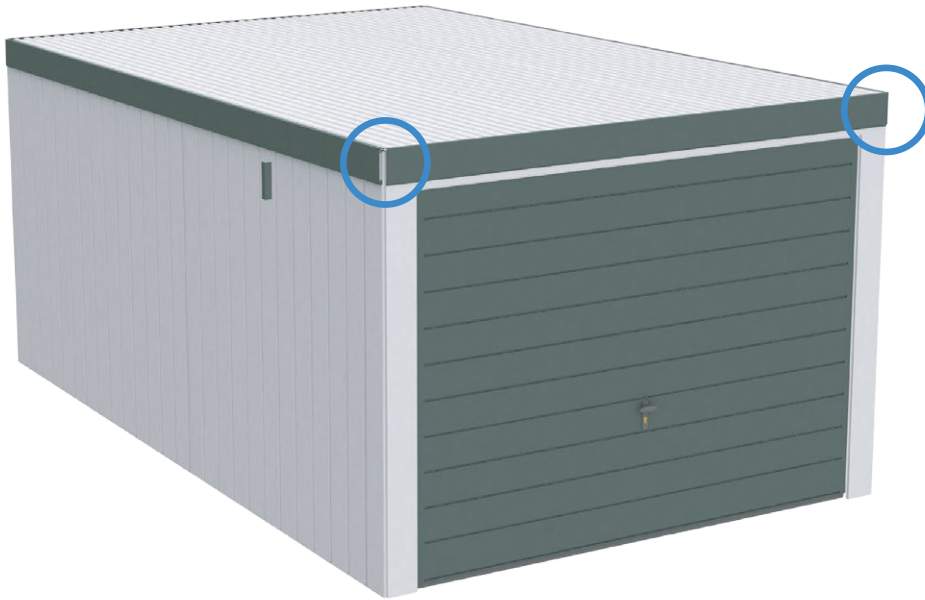

4\*8

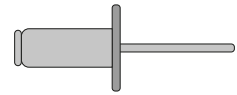

22



23



24

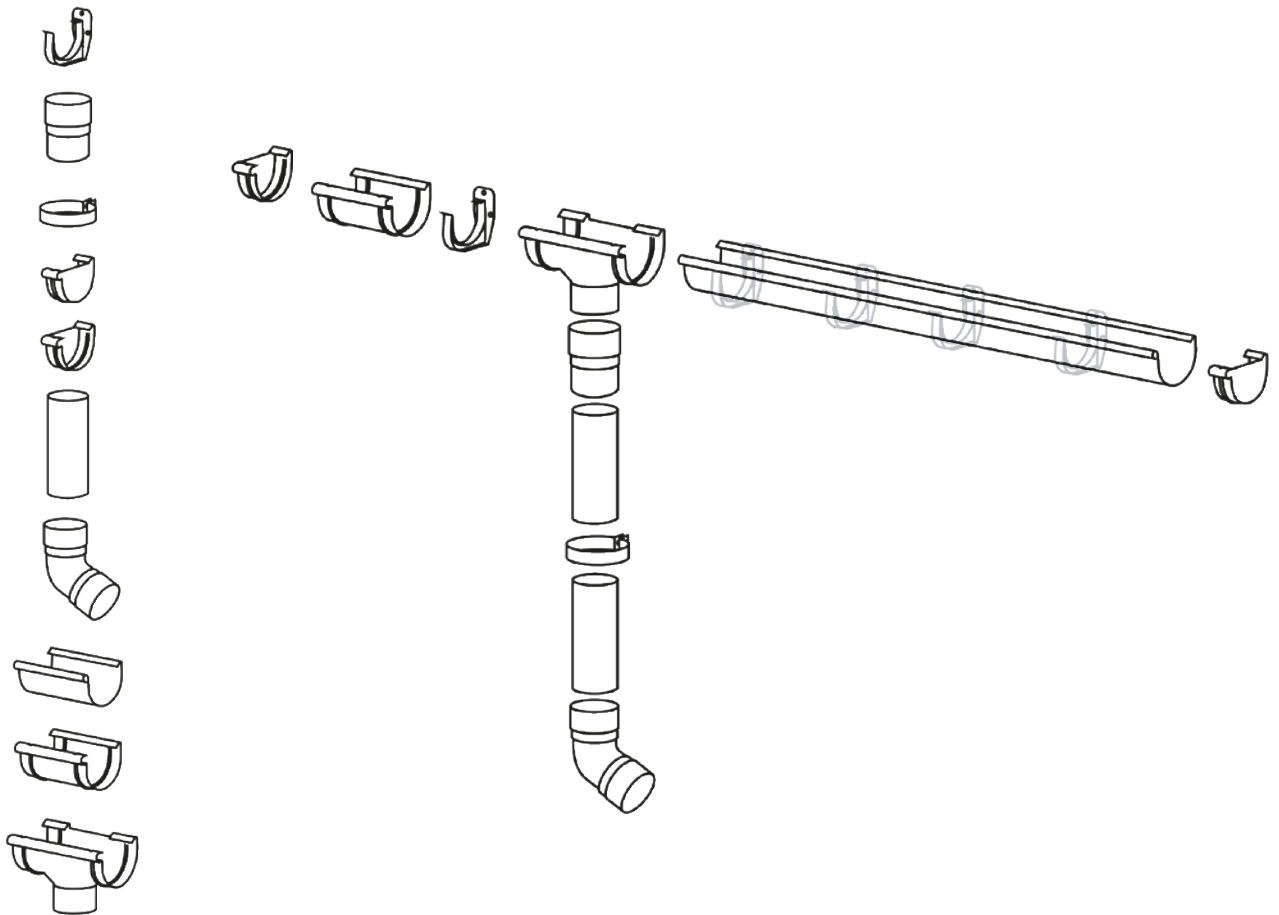





**GRUPPE**

QUALITÄT FÜR HÖCHSTE ANSPRÜCHE

PF GRUPPE FACHHÄNDLER:

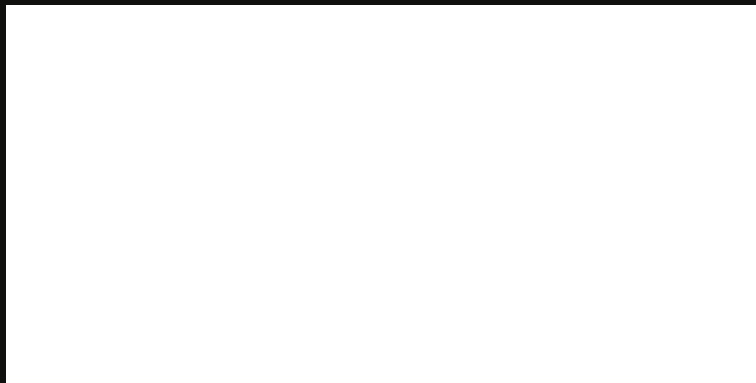

EUROPAWEITER VERTRIEB DURCH DIE



**Baustoff-Euro-Trade**  
GmbH